

Composite dry sliding bushings, metric dimensions

Principal dimensions			Basic load ratings		Mass	Designation
d	D	B	dynamic C	static C0	kg	-
mm	55	60	kN			
50	55	60	236	735	0,19	PCM 505560 E

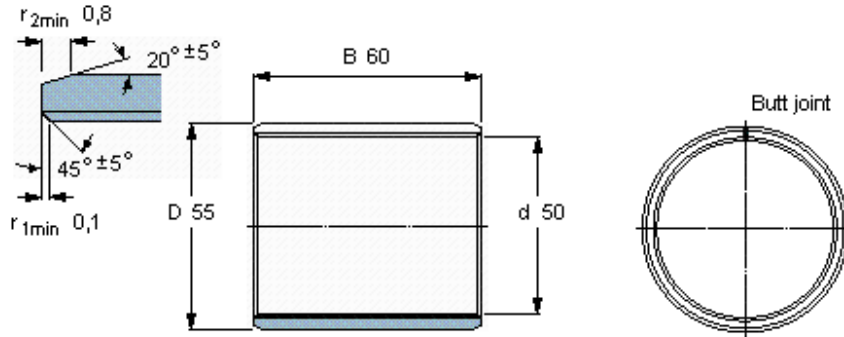

Specific load factor
Material constant

K 80
K_M 480